

## Data Sheet

### Features

- Fits standard Australian wall boxes and mounting accessories that use 84mm mounting centres.
- Combination head screws with a 6mm bore to suit 4 x 2.5mm<sup>2</sup> cable (screws backed out for easier installation of cabling).
- Screw caps included to cover mounting screws.
- LED indicator lights up when switched on.
- Soft touch button activation.
- Covers, plates and buttons are made from UV stabilised polycarbonate to avoid discolouring.
- Silverfish antenna technology.
- Bluetooth mesh connectivity with each device acting as a repeater.
- 2 year warranty.
- Real time energy use in watts & dollars.
- Automatic schedules.
- Auto off timers.
- Power outage recovery.
- Power lock.
- Individual socket control.
- Night light on/off and auto dim.
- High energy use alert.
- Voice control with your favourite voice assistant.\*

*Learn more at [www.zimi.life](http://www.zimi.life)*

### Specifications

Product Code	Colour	Description	Max Load Rating	Line Voltage Freq.
PMPP	White	Powermesh Power Point Switched 2 Gang	10A @ 250V~ 2500W	50Hz Nominal
PMPPBK	Black			

### Dimensions (mm)

Status indicator / night light

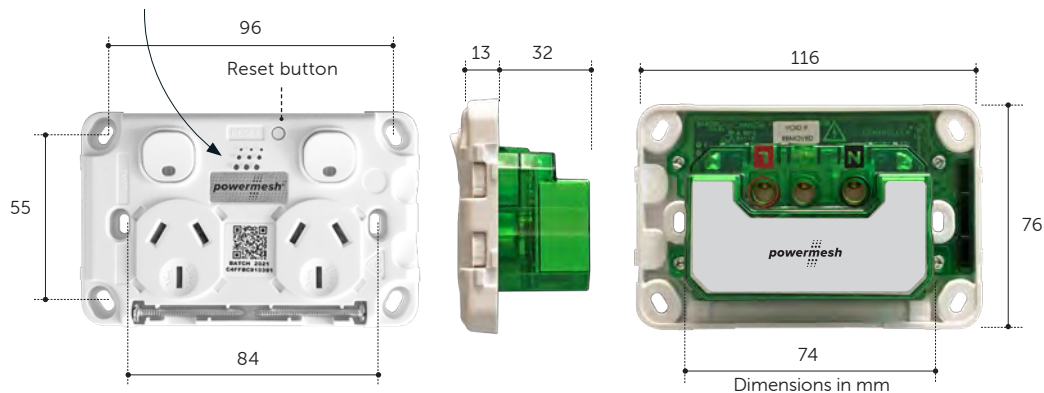

**PMPP**



**PMPPBK**

**Standards Approval:**  
AS/NZS3112 & AS/NZS CISPR15

**Certification Number:**  
GMA-510336-EA

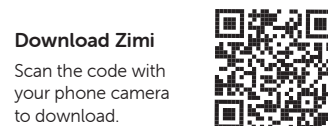

**Download Zimi**  
Scan the code with your phone camera to download.



### \* Zimi Cloud Connect

Enjoy the complete experience of all your Zimi devices with full functionality, reliable connectivity and energy history.



14 Millennium Circuit, Helensvale, QLD 4212 Australia. [www.zimi.life](http://www.zimi.life)

Need help?

email [support@zimi.life](mailto:support@zimi.life)  
visit <https://support.zimi.life>

# Fan Controller with Light Switch



## Data Sheet

### Features

- Fits standard Australian wall boxes and mounting accessories that use 84mm mounting centres.
- Switch terminals have 4mm bore to suit 1.5mm<sup>2</sup> cable.
- Screw caps included to cover mounting screws.
- LED indicator displays on/off state, and fan speed.
- Sliding touch control for fan speed.
- Touch control for light (room or fan light).
- Covers and plates are made from UV stabilised polycarbonate to avoid discolouring.
- Silverfish antenna technology.
- Bluetooth mesh connectivity with each device acting as a repeater.
- 2 year warranty.
- Real time energy use in watts & dollars.
- Automatic schedules.
- Auto off timers.
- Power outage recovery.
- Night light on/off and auto dim.
- Speed Sense technology changes the fan speed with room temperature.
- Behaviour Link with other Zimi devices.
- Voice control with your favourite voice assistant.\*

Learn more at [www.zimi.life](http://www.zimi.life)

### Specifications

Product Code	Colour	Description	
PMFC	White	Powermesh Fan Controller with Light Switch	• <b>Line voltage frequency:</b> 50Hz Nominal
	Black (skin only)		• <b>7 speed capacitor control:</b> 1.1~3.3μF + full speed, suitable for most AC fans.
			• <b>Fan load:</b> 120 watts maximum @ 240V~
			• <b>Light load:</b> 250 watts maximum @ 240V~

### Dimensions (mm)

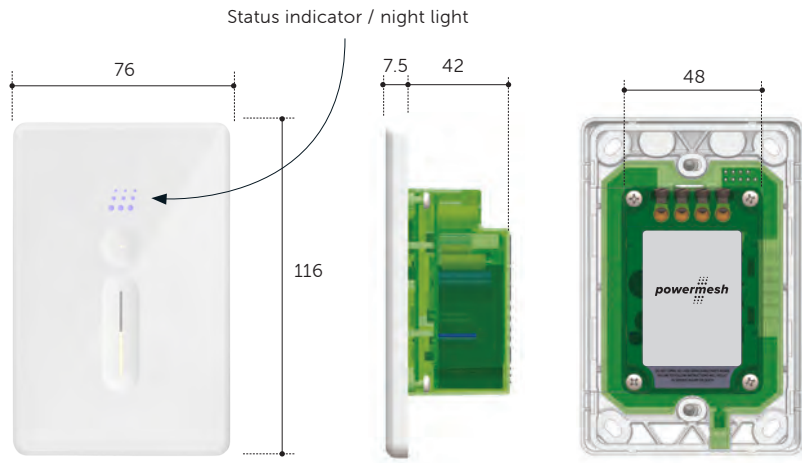

PMFC



PMFCCBK

Black skin only.

### Standards Approval:

AS/NZ60669.2.1 & AS/NZS CISPR15

### Certification Number:

GMA-506666-EA



### Download Zimi

Scan the code with your phone camera to download.



### \* Zimi Cloud Connect

Enjoy the complete experience of all your Zimi devices with full functionality, reliable connectivity and energy history.



14 Millennium Circuit, Helensvale, QLD 4212 Australia. [www.zimi.life](http://www.zimi.life)

Need help?

email [support@zimi.life](mailto:support@zimi.life)  
visit <https://support.zimi.life>

# Light Dimmer



## Data Sheet

### Features

- Fits standard Australian wall boxes and mounting accessories that use 84mm mounting centres.
- Switch terminals have 4mm bore to suit 1.5mm<sup>2</sup> cable.
- Screw caps included to cover mounting screws.
- Mini indicator displays the brightness level.
- Trailing edge dimmer.
- Supports 2 wire (no neutral) via selector switch.
- Master & slave switch for 2 & 3 way dimming.
- Covers, plates and buttons are made from UV stabilised polycarbonate to avoid discolouring.
- Bluetooth mesh connectivity with each device acting as a repeater.
- 2 year warranty.
- Soft touch button and dimming control.  
Press for on/off  
Hold for dimming  
Double press for full brightness  
Triple press for a timed fade to off.
- Auto off timers.
- Real time energy use in watts & dollars.
- Automatic schedules.
- Power outage recovery.
- Night light on/off and auto dim.
- Min and max dimming levels for increased compatibility without flicker.
- Voice control with your favourite voice assistant.\*

Learn more at [www.zimi.life](http://www.zimi.life).

### Specifications

Product Code	Colour	Description
PMPUSWV1GS	White	Powermesh Light Dimmer
PMPUSWV1GSBKS	Black	

- **Line voltage frequency:** 50Hz Nominal
- **Load brightness control range:** 1% to >95% (load dependant)
- **Rated load:** Maximum 1A @ 250V ~ 250W
- **Minimum load:** 2W

### Dimensions (mm)

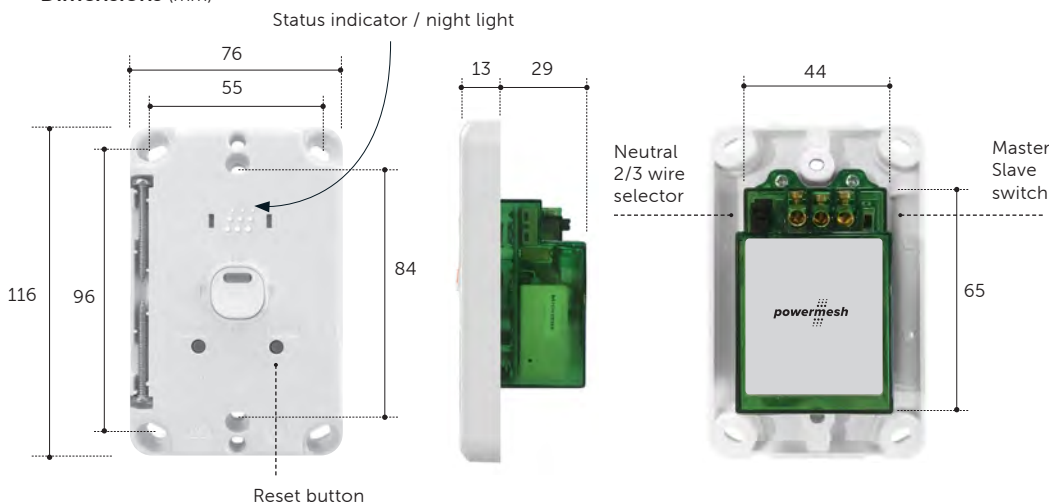

**PMPUSWV1GS**



**PMPUSWV1GSBKS**

**Standards Approval:**  
AS/NZ60669.2.1 & AS/NZS CISPR15

**Certification Number:**  
GMA-504509-EA



### Download Zimi

Scan the code with your phone camera to download.



### \* Zimi Cloud Connect

Enjoy the complete experience of all your Zimi devices with full functionality, reliable connectivity and energy history.



### Compatible load types

- Dimmable LED drivers & lamps
- 12V electronic transformers
- Standard iron core & toroidal transformers
- Incandescent

**zimi** 14 Millennium Circuit, Helensvale, QLD 4212 Australia. [www.zimi.life](http://www.zimi.life)

Need help?

email [support@zimi.life](mailto:support@zimi.life)  
visit <https://support.zimi.life>

Powermesh products must be installed by a qualified electrician. Zimi requires a compatible (Android, iOS) mobile device, minimum OS requirements are available at [www.zimi.life](http://www.zimi.life). Availability and performance of certain features are service, device and network-dependent and may not be available in all areas; subscription(s) may be required, and additional terms, conditions and/or charges may apply. All features, functionality and other product specifications are subject to change without notice or obligation. Powermesh products are optimised for the use with the Zimi App. The Bluetooth word mark and logos are registered trademarks owned by the Bluetooth SIG, Inc. iOS is a trademark or registered trademark of Cisco Inc. Zimi and Powermesh and their respective logos are registered trademarks of Zimi Ltd. Google and Google Play are trademarks of Google LLC. Amazon, Alexa, and all related logos are trademarks of Amazon.com, Inc. or its affiliates. Apple, the Apple logo, Apple Watch and iPhone are trademarks of Apple Inc., registered in the U.S. and other countries. App Store is a service mark of Apple Inc., registered in the U.S. and other countries. Copyright © 2022 Zimi Ltd. All rights reserved.

# Multi Purpose Switch

## 1 Button



### Data Sheet

#### Features

- Fits standard Australian wall boxes and mounting accessories that use 84mm mounting centres.
- Switch terminals have 4mm bore to suit 1.5mm<sup>2</sup> cable.
- Soft touch button control.
- Neutral connection not required (2 wire); connect neutral if available (3 wire).
- Auto sensing of 3 wire and 2 wire (no neutral mode).
- LED indicator displays on/off state.
- Covers, plates and buttons are made from UV stabilised polycarbonate to avoid discolouring.
- Silverfish antenna technology.
- Bluetooth mesh connectivity with each device acting as a repeater.
- 2 year warranty.
- Real time energy use in watts & dollars.
- Automatic schedules.
- Auto off timers.
- Power outage recovery.
- Night light on/off and auto dim.
- Multi way switching of other Zimi devices using Behaviour Link.
- Voice control with your favourite voice assistant.\*

Learn more at [www.zimi.life](http://www.zimi.life)

#### Specifications

Product Code	Colour	Description	
PMMP51	White	Powermesh Multi Purpose Switch 1 Button	<ul style="list-style-type: none"> <li>• <b>Motor Rating:</b> M40</li> <li>• <b>3 wire with Neutral:</b> 240V~ 5AX maximum</li> <li>• <b>2 wire without Neutral:</b> 240V~ 5A maximum for channel one, suitable load required.</li> </ul>
PMMP51BK	Black		

**Always use a Neutral wire where possible.** When operating without a neutral connected, a small amount of power is used via LOAD 1 when switched off. This may in some instances result with lights not completely turning off. **Dimmable** loads might be fixed by increasing to at least 2 lights with a load >10W. **Non-Dimmable** loads may require a bypass/load correction device fitted if the load is insufficient.

#### Dimensions (mm)

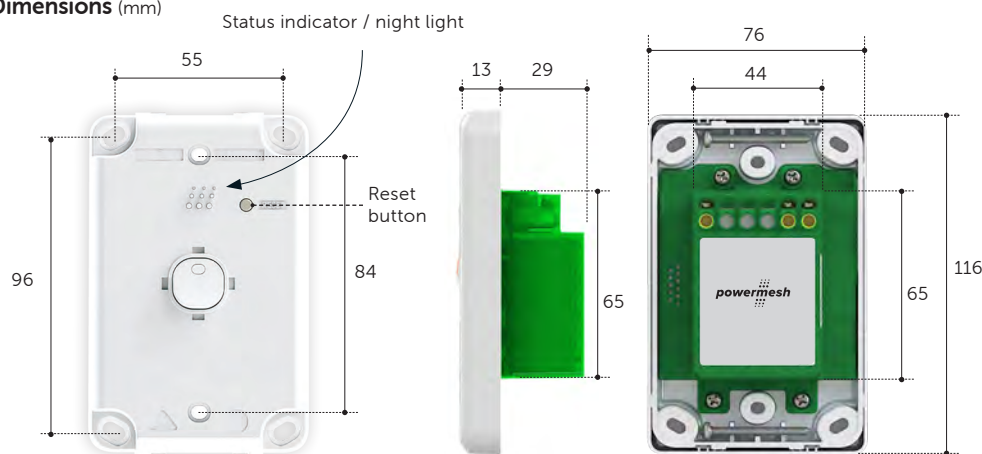

#### Compatible load types\*

LED	Electronic transformers
Incandescent	Standard iron core & toroidal transformers
Fluorescent	Exhaust fans small motors
CFLs	



PMMP51



PMMP51BK

**Standards Approval:**  
AS/NZ60669.2.1 & AS/NZS CISPR15

**Certification Number:**  
GMA-506936-EA



**Download Zimi**  
Scan the code with your phone camera to download.



#### \* Zimi Cloud Connect

Enjoy the complete experience of all your Zimi devices with full functionality, reliable connectivity and energy history.



**zimi** 14 Millennium Circuit, Helensvale, QLD 4212 Australia. [www.zimi.life](http://www.zimi.life)

Need help? email [support@zimi.life](mailto:support@zimi.life)  
visit <https://support.zimi.life>

# Multi Purpose Switch

## 2 Button



### Data Sheet

#### Features

- Fits standard Australian wall boxes and mounting accessories that use 84mm mounting centres.
- Switch terminals have 4mm bore to suit 1.5mm<sup>2</sup> cable.
- Soft touch button control.
- Neutral connection not required (2 wire); connect neutral if available (3 wire).
- Auto sensing of 3 wire and 2 wire (no neutral mode).
- LED indicator displays on/off state.
- Covers, plates and buttons are made from UV stabilised polycarbonate to avoid discolouring.
- Silverfish antenna technology.
- Bluetooth mesh connectivity with each device acting as a repeater.
- 2 year warranty.
- Real time energy use in watts & dollars.
- Automatic schedules.
- Auto off timers.
- Power outage recovery.
- Night light on/off and auto dim.
- Multi way switching of other Zimi devices using Behaviour Link.
- Voice control with your favourite voice assistant.\*

Learn more at [www.zimi.life](http://www.zimi.life)

#### Specifications

Product Code	Colour	Description
PMMP2	White	Powermesh Multi Purpose Switch 2 Button
PMMP2BK	Black	

- Motor Rating: M40
- 3 wire with Neutral: 240V~ 5AX max per channel, 10AX total max load.
- 2 wire without Neutral: 240V~ 5AX max per channel, channel 1 is 5A only.

Always use a Neutral wire where possible. When operating without a neutral connected, a small amount of power is used via LOAD 1 when switched off. This may in some instances result with lights not completely turning off. Dimmable loads might be fixed by increasing to at least 2 lights with a load >10W. Non-Dimmable loads may require a bypass/load correction device fitted if the load is insufficient.

#### Dimensions (mm)

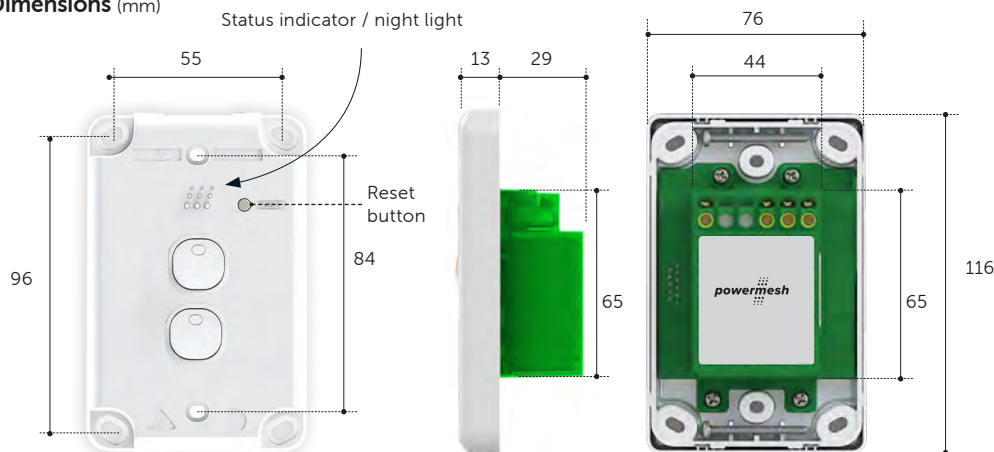

#### Compatible load types\*

LED	Electronic transformers
Incandescent	Standard iron core & toroidal transformers
Fluorescent	Exhaust fans small motors
CFLs	



PMMP2



PMMP2BK

Standards Approval:  
AS/NZ60669.2.1 & AS/NZS CISPR15

Certification Number:  
GMA-506936-EA



Download Zimi  
Scan the code with your phone camera to download.



#### \* Zimi Cloud Connect

Enjoy the complete experience of all your Zimi devices with full functionality, reliable connectivity and energy history.



**zimi** 14 Millennium Circuit, Helensvale, QLD 4212 Australia. [www.zimi.life](http://www.zimi.life)

Need help? email [support@zimi.life](mailto:support@zimi.life) visit <https://support.zimi.life>

Powermesh products must be installed by a qualified electrician. Zimi requires a compatible (Android, iOS) mobile device, minimum OS requirements are available at [www.zimi.life](http://www.zimi.life). Availability and performance of certain features are service, device and network-dependent and may not be available in all areas; subscription(s) may be required, and additional terms, conditions and/or charges may apply. All features, functionality and other product specifications are subject to change without notice or obligation. Powermesh products are optimised for the use with the Zimi App. The Bluetooth word mark and logos are registered trademarks owned by the Bluetooth SIG, Inc. iOS is a trademark or registered trademark of Cisco Inc. Zimi and Powermesh and their respective logos are registered trademarks of Zimi Ltd. Google and Google Play are trademarks of Google LLC. Amazon, Alexa, and all related logos are trademarks of Amazon.com, Inc. or its affiliates. Apple, the Apple logo, Apple Watch and iPhone are trademarks of Apple Inc., registered in the U.S. and other countries. App Store is a service mark of Apple Inc., registered in the U.S. and other countries. Copyright © 2022 Zimi Ltd. All rights reserved.



# Multi Purpose Switch

## 3 Button



### Data Sheet

#### Features

- Fits standard Australian wall boxes and mounting accessories that use 84mm mounting centres.
- Switch terminals have 4mm bore to suit 1.5mm<sup>2</sup> cable.
- Soft touch button control.
- Neutral connection not required (2 wire); connect neutral if available (3 wire).
- Auto sensing of 3 wire and 2 wire (no neutral mode).
- LED indicator displays on/off state.
- Covers, plates and buttons are made from UV stabilised polycarbonate to avoid discolouring.
- Silverfish antenna technology.
- Bluetooth mesh connectivity with each device acting as a repeater.
- 2 year warranty.
- Real time energy use in watts & dollars.
- Automatic schedules.
- Auto off timers.
- Power outage recovery.
- Night light on/off and auto dim.
- Multi way switching of other Zimi devices using Behaviour Link.
- Voice control with your favourite voice assistant.\*

Learn more at [www.zimi.life](http://www.zimi.life)

#### Specifications

Product Code	Colour	Description
PMMP3	White	Powermesh Multi Purpose Switch 3 Button
PMMP3BK	Black	

- Motor Rating:** M40
- 3 wire with Neutral:** 240V~ 5AX max per channel, 10AX max load.
- 2 wire without Neutral:** 240V~ 5AX max per channel, channel 1 is 5A only.

**Always use a Neutral wire where possible.** When operating without a neutral connected, a small amount of power is used via LOAD 1 when switched off. This may in some instances result with lights not completely turning off. **Dimmable** loads might be fixed by increasing to at least 2 lights with a load >10W. **Non-Dimmable** loads may require a bypass/load correction device fitted if the load is insufficient.

#### Dimensions (mm)

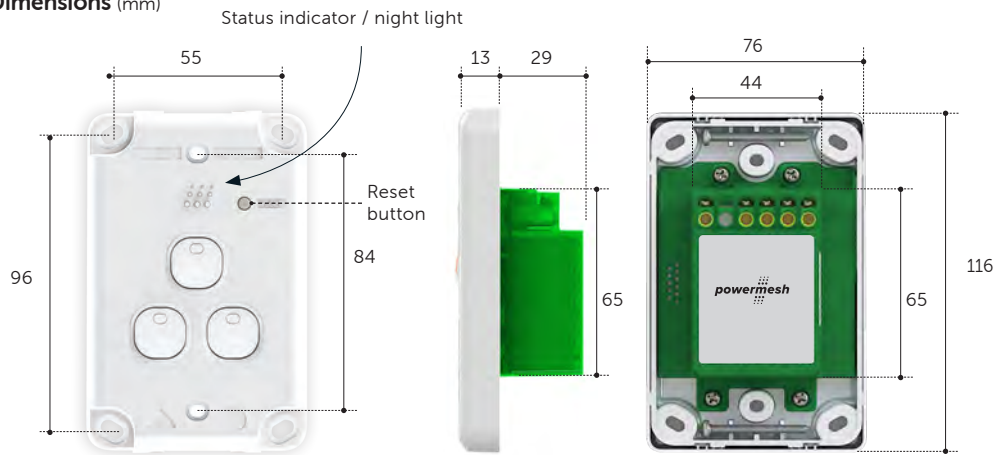

#### Compatible load types\*

LED	Electronic transformers
Incandescent	Standard iron core & toroidal transformers
Fluorescent	Exhaust fans small motors
CFLs	



PMMP3



PMMP3BK

#### Standards Approval:

AS/NZ60669.2.1 & AS/NZS CISPR15

#### Certification Number:

GMA-506939-EA



#### Download Zimi

Scan the code with your phone camera to download.



#### \* Zimi Cloud Connect

Enjoy the complete experience of all your Zimi devices with full functionality, reliable connectivity and energy history.



14 Millennium Circuit, Helensvale, QLD 4212 Australia. [www.zimi.life](http://www.zimi.life)

Need help?

email [support@zimi.life](mailto:support@zimi.life)  
visit <https://support.zimi.life>

# Multi Purpose Switch

## 4 Button



### Data Sheet

#### Features

- Fits standard Australian wall boxes and mounting accessories that use 84mm mounting centres.
- Switch terminals have 4mm bore to suit 1.5mm<sup>2</sup> cable.
- Soft touch button control.
- Neutral connection not required (2 wire); connect neutral if available (3 wire).
- Auto sensing of 3 wire and 2 wire (no neutral mode).
- LED indicator displays on/off state.
- Covers, plates and buttons are made from UV stabilised polycarbonate to avoid discolouring.
- Silverfish antenna technology.
- 2 year warranty.
- Bluetooth mesh connectivity with each device acting as a repeater.
- Real time energy use in watts & dollars.
- Automatic schedules.
- Auto off timers.
- Power outage recovery.
- Night light on/off and auto dim.
- Multi way switching of other Zimi devices using Behaviour Link.
- Voice control with your favourite voice assistant.\*

Learn more at [www.zimi.life](http://www.zimi.life)

#### Specifications

Product Code	Colour	Description
PMMP54	White	Powermesh Multi Purpose Switch
PMMP54BK	Black	4 Button

- **Motor Rating:** M40
- **3 wire with Neutral:** 240V~ 5AX max per channel, 10AX max load.
- **2 wire without Neutral:** 240V~ 5AX max per channel, channel 1 is 5A only.

**Always use a Neutral wire where possible.** When operating without a neutral connected, a small amount of power is used via LOAD 1 when switched off. This may in some instances result with lights not completely turning off. **Dimmable** loads might be fixed by increasing to at least 2 lights with a load >10W. **Non-Dimmable** loads may require a bypass/load correction device fitted if the load is insufficient.

#### Dimensions (mm)

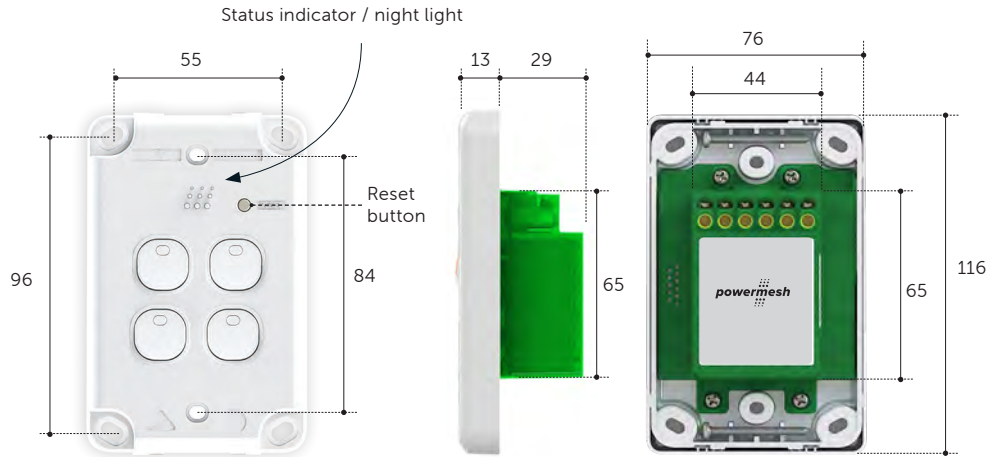

#### Compatible load types\*

LED	Electronic transformers
Incandescent	Standard iron core & toroidal transformers
Fluorescent	Exhaust fans small motors
CFLs	



PMMP54



PMMP54BK

#### Standards Approval:

AS/NZ60669.2.1 & AS/NZS CISPR15

#### Certification Number:

GMA-506939-EA



#### Download Zimi

Scan the code with your phone camera to download.



#### \* Zimi Cloud Connect

Enjoy the complete experience of all your Zimi devices with full functionality, reliable connectivity and energy history.



14 Millennium Circuit, Helensvale, QLD 4212 Australia. [www.zimi.life](http://www.zimi.life)

Need help?

email [support@zimi.life](mailto:support@zimi.life)  
visit <https://support.zimi.life>

# Multi Purpose Switch

## 1 Button Horizontal



### Data Sheet

#### Features

- Fits standard Australian wall boxes and mounting accessories that use 84mm mounting centres.
- Switch terminals have 4mm bore to suit 1.5mm<sup>2</sup> cable.
- Soft touch button control.
- Neutral connection not required (2 wire); connect neutral if available (3 wire).
- Auto sensing of 3 wire and 2 wire (no neutral mode).
- LED indicator displays on/off state.
- Covers, plates and buttons are made from UV stabilised polycarbonate to avoid discolouring.
- Silverfish antenna technology.
- 2 year warranty.
- Bluetooth mesh connectivity with each device acting as a repeater.
- Real time energy use in watts & dollars.
- Automatic schedules.
- Auto off timers.
- Power outage recovery.
- Night light on/off and auto dim.
- Multi way switching of other Zimi devices using Behaviour Link.
- Voice control with your favourite voice assistant.\*

Learn more at [www.zimi.life](http://www.zimi.life)

#### Specifications

Product Code	Colour	Description
PMMP51H	White	Powermesh Multi Purpose Switch 1 Button Horizontal
PMMP51HBK	Black	

- **Motor Rating:** M40
- **3 wire with Neutral:** 240V~ 5AX maximum
- **2 wire without Neutral:** 240V~ 5A maximum for channel one, suitable load required.

**Always use a Neutral wire where possible.** When operating without a neutral connected, a small amount of power is used via LOAD 1 when switched off. This may in some instances result with lights not completely turning off. **Dimmable** loads might be fixed by increasing to at least 2 lights with a load >10W. **Non-Dimmable** loads may require a bypass/load correction device fitted if the load is insufficient.

#### Dimensions (mm)

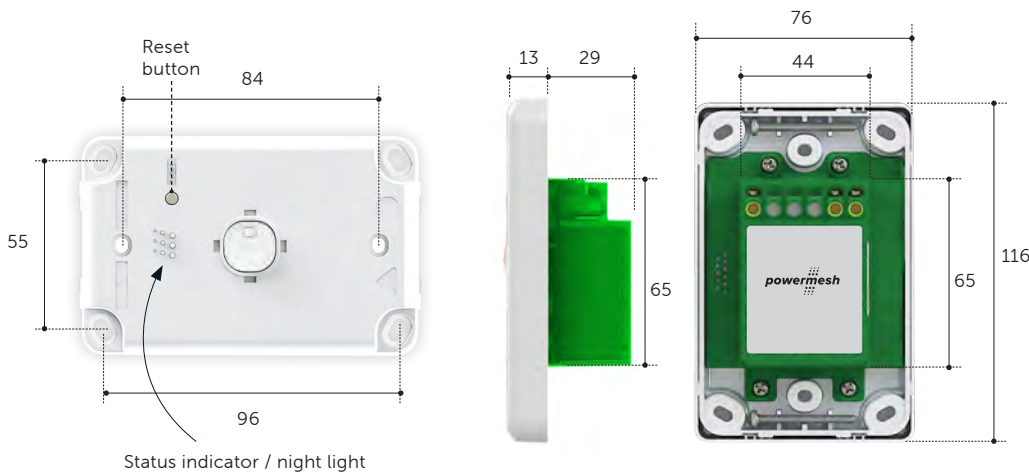

#### Compatible load types\*

LED	Electronic transformers
Incandescent	Standard iron core & toroidal transformers
Fluorescent	Exhaust fans small motors
CFLs	



PMMP51H



PMMP51HBK

**Standards Approval:**  
AS/NZ60669.2.1 & AS/NZS CISPR15

**Certification Number:**  
GMA-506936-EA



**Download Zimi**  
Scan the code with your phone camera to download.



#### \* Zimi Cloud Connect

Enjoy the complete experience of all your Zimi devices with full functionality, reliable connectivity and energy history.



**zimi** 14 Millennium Circuit, Helensvale, QLD 4212 Australia. [www.zimi.life](http://www.zimi.life)

Need help? email [support@zimi.life](mailto:support@zimi.life)  
visit <https://support.zimi.life>

Powermesh products must be installed by a qualified electrician. Zimi requires a compatible (Android, iOS) mobile device, minimum OS requirements are available at [www.zimi.life](http://www.zimi.life). Availability and performance of certain features are service, device and network-dependent and may not be available in all areas; subscription(s) may be required, and additional terms, conditions and/or charges may apply. All features, functionality and other product specifications are subject to change without notice or obligation. Powermesh products are optimised for the use with the Zimi App. The Bluetooth word mark and logos are registered trademarks owned by the Bluetooth SIG, Inc. iOS is a trademark or registered trademark of Cisco Inc. Zimi and Powermesh and their respective logos are registered trademarks of Zimi Ltd. Google and Google Play are trademarks of Google LLC. Amazon, Alexa, and all related logos are trademarks of Amazon.com, Inc. or its affiliates. Apple, the Apple logo, Apple Watch and iPhone are trademarks of Apple Inc., registered in the U.S. and other countries. App Store is a service mark of Apple Inc., registered in the U.S. and other countries. Copyright © 2022 Zimi Ltd. All rights reserved.



# Multi Purpose Switch

## 2 Button Horizontal



### Data Sheet

#### Features

- Fits standard Australian wall boxes and mounting accessories that use 84mm mounting centres.
- Switch terminals have 4mm bore to suit 1.5mm<sup>2</sup> cable.
- Soft touch button control.
- Neutral connection not required (2 wire); connect neutral if available (3 wire).
- Auto sensing of 3 wire and 2 wire (no neutral mode).
- LED indicator displays on/off state.
- Covers, plates and buttons are made from UV stabilised polycarbonate to avoid discolouring.
- Silverfish antenna technology.
- 2 year warranty.
- Bluetooth mesh connectivity with each device acting as a repeater.
- Real time energy use in watts & dollars.
- Automatic schedules.
- Auto off timers.
- Power outage recovery.
- Night light on/off and auto dim.
- Multi way switching of other Zimi devices using Behaviour Link.
- Voice control with your favourite voice assistant.\*

Learn more at [www.zimi.life](http://www.zimi.life)

#### Specifications

Product Code	Colour	Description
PMMP2H	White	Powermesh Multi Purpose Switch
PMMP2HBK	Black	2 Button Horizontal

- **Motor Rating:** M40
- **3 wire with Neutral:** 240V~ 5AX max per channel, 10AX total max load.
- **2 wire without Neutral:** 240V~ 5AX max per channel, channel 1 is 5A only.

**Always use a Neutral wire where possible.** When operating without a neutral connected, a small amount of power is used via LOAD 1 when switched off. This may in some instances result with lights not completely turning off. **Dimmable** loads might be fixed by increasing to at least 2 lights with a load >10W. **Non-Dimmable** loads may require a bypass/load correction device fitted if the load is insufficient.

#### Dimensions (mm)

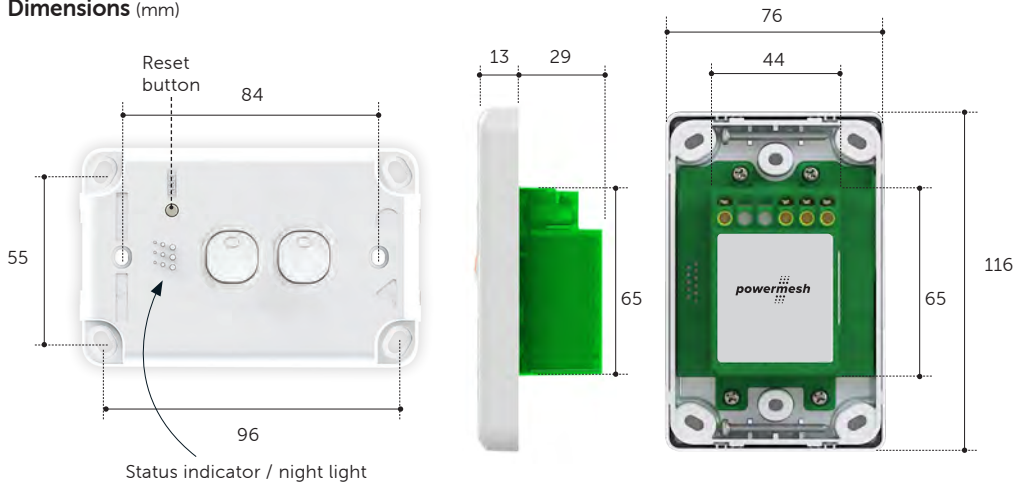

#### Compatible load types\*

LED	Electronic transformers
Incandescent	Standard iron core & toroidal transformers
Fluorescent	Exhaust fans small motors
CFLs	



PMMP2H



PMMP2HBK

**Standards Approval:**  
AS/NZ60669.2.1 & AS/NZS CISPR15

**Certification Number:**  
GMA-506936-EA



**Download Zimi**  
Scan the code with your phone camera to download.



#### \* Zimi Cloud Connect

Enjoy the complete experience of all your Zimi devices with full functionality, reliable connectivity and energy history.



**zimi** 14 Millennium Circuit, Helensvale, QLD 4212 Australia. [www.zimi.life](http://www.zimi.life)

Need help? email [support@zimi.life](mailto:support@zimi.life)  
visit <https://support.zimi.life>

Powermesh products must be installed by a qualified electrician. Zimi requires a compatible (Android, iOS) mobile device, minimum OS requirements are available at [www.zimi.life](http://www.zimi.life). Availability and performance of certain features are service, device and network-dependent and may not be available in all areas; subscription(s) may be required, and additional terms, conditions and/or charges may apply. All features, functionality and other product specifications are subject to change without notice or obligation. Powermesh products are optimised for the use with the Zimi App. The Bluetooth word mark and logos are registered trademarks owned by the Bluetooth SIG, Inc. iOS is a trademark or registered trademark of Cisco Inc. Zimi and Powermesh and their respective logos are registered trademarks of Zimi Ltd. Google and Google Play are trademarks of Google LLC. Amazon, Alexa, and all related logos are trademarks of Amazon.com, Inc. or its affiliates. Apple, the Apple logo, Apple Watch and iPhone are trademarks of Apple Inc., registered in the U.S. and other countries. App Store is a service mark of Apple Inc., registered in the U.S. and other countries. Copyright © 2022 Zimi Ltd. All rights reserved.

# Multi Purpose Switch

## 4 Button Horizontal



### Data Sheet

#### Features

- Fits standard Australian wall boxes and mounting accessories that use 84mm mounting centres.
- Switch terminals have 4mm bore to suit 1.5mm<sup>2</sup> cable.
- Soft touch button control.
- Neutral connection not required (2 wire); connect neutral if available (3 wire).
- Auto sensing of 3 wire and 2 wire (no neutral mode).
- LED indicator displays on/off state.
- Covers, plates and buttons are made from UV stabilised polycarbonate to avoid discolouring.
- Silverfish antenna technology.
- 2 year warranty.
- Bluetooth mesh connectivity with each device acting as a repeater.
- Real time energy use in watts & dollars.
- Automatic schedules.
- Auto off timers.
- Power outage recovery.
- Night light on/off and auto dim.
- Multi way switching of other Zimi devices using Behaviour Link.
- Voice control with your favourite voice assistant.\*

Learn more at [www.zimi.life](http://www.zimi.life)

#### Specifications

Product Code	Colour	Description
PMMP54H	White	Powermesh Multi Purpose Switch
PMMP54HBK	Black	4 Button Horizontal

- **Motor Rating:** M40
- **3 wire with Neutral:** 240V~ 5AX max per channel, 10AX max load.
- **2 wire without Neutral:** 240V~ 5AX max per channel, channel 1 is 5A only.

**Always use a Neutral wire where possible.** When operating without a neutral connected, a small amount of power is used via LOAD 1 when switched off. This may in some instances result with lights not completely turning off. **Dimmable** loads might be fixed by increasing to at least 2 lights with a load >10W. **Non-Dimmable** loads may require a bypass/load correction device fitted if the load is insufficient.

#### Dimensions (mm)

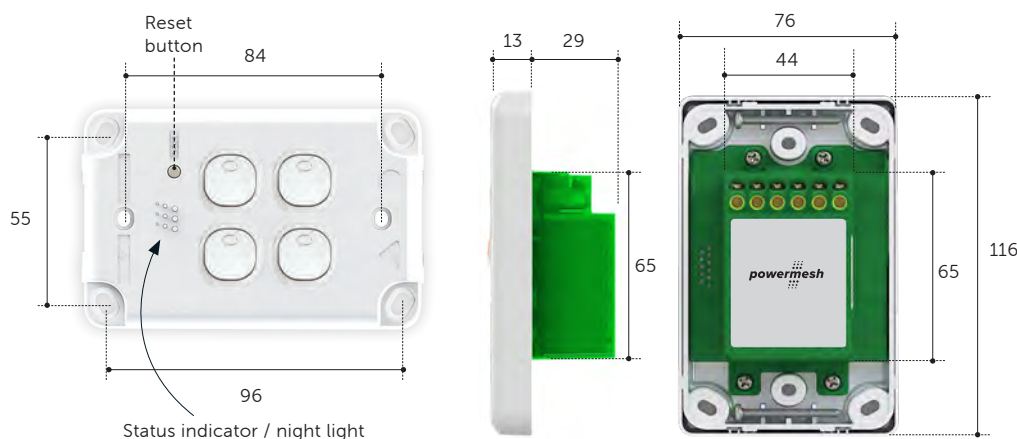

#### Compatible load types\*

LED	Electronic transformers
Incandescent	Standard iron core & toroidal transformers
Fluorescent	Exhaust fans small motors
CFLs	



PMMP54H



PMMP54HBK

**Standards Approval:**  
AS/NZ60669.2.1 & AS/NZS CISPR15

**Certification Number:**  
GMA-506936-EA



#### Download Zimi

Scan the code with your phone camera to download.



#### \* Zimi Cloud Connect

Enjoy the complete experience of all your Zimi devices with full functionality, reliable connectivity and energy history.



14 Millennium Circuit, Helensvale, QLD 4212 Australia. [www.zimi.life](http://www.zimi.life)

Need help?

email [support@zimi.life](mailto:support@zimi.life)  
visit <https://support.zimi.life>

# Zimi Cloud Connect

## Data Sheet

### Features

- Connects your Zimi device network to the Internet and provides full functionality of all Zimi devices.
- Colour LED status indicator.
- 5V DC - 500mA plug pack included.
- Silverfish antenna technology.
- Bluetooth mesh connectivity with each device acting as a repeater.
- 2 year warranty.
- Provides Zimi app access to Zimi devices anywhere in world via Wi-Fi and Internet.
- Enables energy use history.
- Reliable network connectivity.
- Sunrise and sunset schedules.
- Voice control with your favourite voice assistant.\*

**Learn more at [www.zimi.life](http://www.zimi.life)**

### Specifications

Product Code	Colour	Description	Power	Wi-Fi Connectivity
ZCCD	White	Zimi Cloud Connect	5V DC - 500mA plug pack included	2.4GHz

### Dimensions (mm)

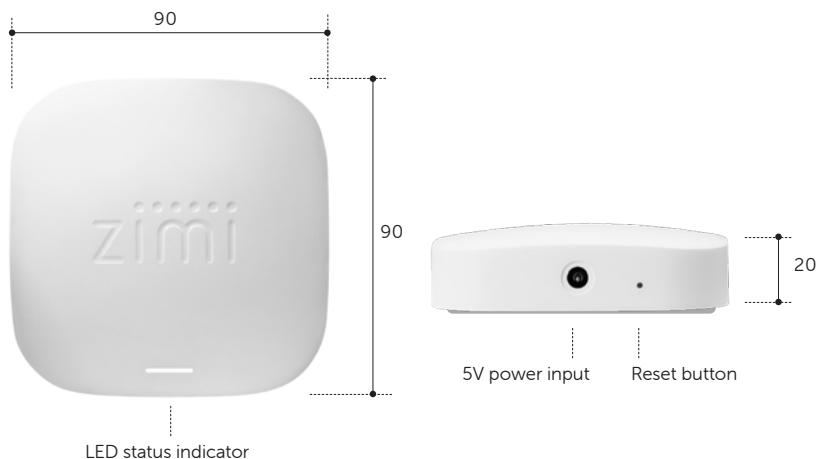

ZCCD



**zimi** 14 Millennium Circuit, Helensvale,  
QLD 4212 Australia. [www.zimi.life](http://www.zimi.life)

Need help?

email [support@zimi.life](mailto:support@zimi.life)  
visit <https://support.zimi.life>

**Download Zimi**  
Scan the code with  
your phone camera  
to download.



Powermesh products must be installed by a qualified electrician. Zimi requires a compatible (Android, iOS) mobile device, minimum OS requirements are available at [www.zimi.life](http://www.zimi.life). Availability and performance of certain features are service, device and network-dependent and may not be available in all areas; subscription(s) may be required, and additional terms, conditions and/or charges may apply. All features, functionality and other product specifications are subject to change without notice or obligation. Powermesh products are optimised for the use with the Zimi App. The Bluetooth word mark and logos are registered trademarks owned by the Bluetooth SIG, Inc. iOS is a trademark or registered trademark of Cisco Inc. Zimi and Powermesh and their respective logos are registered trademarks of Zimi Ltd. Google and Google Play are trademarks of Google LLC. Amazon, Alexa, and all related logos are trademarks of Amazon.com, Inc. or its affiliates. Apple, the Apple logo, Apple Watch and iPhone are trademarks of Apple Inc., registered in the U.S. and other countries. App Store is a service mark of Apple Inc., registered in the U.S. and other countries. Copyright © 2022 Zimi Ltd. All rights reserved.

ZCCD / Revision 1.2 / November 2022

# Zimi Cloud Connect

## Data Sheet

### Features

- Connects your Zimi device network to the Internet and provides full functionality of all Zimi devices.
- Colour LED status indicator.
- 5V DC - 500mA plug pack included.
- Silverfish antenna technology.
- Bluetooth mesh connectivity with each device acting as a repeater.
- 2 year warranty.
- Provides Zimi app access to Zimi devices anywhere in world via Wi-Fi and Internet.
- Enables energy use history.
- Reliable network connectivity.
- Sunrise and sunset schedules.
- Voice control with your favourite voice assistant.\*

*Learn more at [www.zimi.life](http://www.zimi.life)*

### Specifications

Product Code	Colour	Description	Power	Wi-Fi Connectivity
PMZCLOUDV1	White	Zimi Cloud Connect	5V DC - 500mA plug pack included	2.4GHz

### Dimensions (mm)

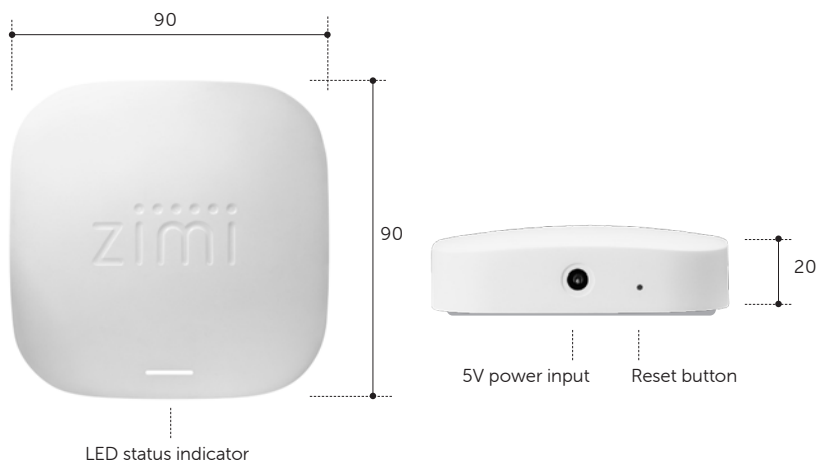

**PMZCLOUDV1**



**zimi** 14 Millennium Circuit, Helensvale,  
QLD 4212 Australia. [www.zimi.life](http://www.zimi.life)

Need help? email [support@zimi.life](mailto:support@zimi.life)  
visit <https://support.zimi.life>

**Download Zimi**  
Scan the code with  
your phone camera  
to download.



Powermesh products must be installed by a qualified electrician. Zimi requires a compatible (Android, iOS) mobile device, minimum OS requirements are available at [www.zimi.life](http://www.zimi.life). Availability and performance of certain features are service, device and network-dependent and may not be available in all areas; subscription(s) may be required, and additional terms, conditions and/or charges may apply. All features, functionality and other product specifications are subject to change without notice or obligation. Powermesh products are optimised for the use with the Zimi App. The Bluetooth word mark and logos are registered trademarks owned by the Bluetooth SIG, Inc. iOS is a trademark or registered trademark of Cisco Inc. Zimi and Powermesh and their respective logos are registered trademarks of Zimi Ltd. Google and Google Play are trademarks of Google LLC. Amazon, Alexa, and all related logos are trademarks of Amazon.com, Inc. or its affiliates. Apple, the Apple logo, Apple Watch and iPhone are trademarks of Apple Inc., registered in the U.S. and other countries. App Store is a service mark of Apple Inc., registered in the U.S. and other countries. Copyright © 2022 Zimi Ltd. All rights reserved.

# Garage Door Controller with Door Sensor



## Data Sheet

### Features

- Works with existing motors using the push button terminals. \*\*
- Door Sensor supports roller, sectional and tilt doors.
- Controller supports up to 2 doors (additional sensor required).
- Monitors the garage temperature and humidity.
- Quick connector for easy installation.
- Power Plug Pack, Door Sensor and battery included.
- Voice control with your favourite voice assistant.\*
- Silverfish antenna technology.
- 2 year warranty.

Learn more at [www.zimi.life](http://www.zimi.life)

### PMGCK Specifications

Product Code	Description	Communication	
PMGC	Powermesh Garage Door Controller	Bluetooth®	<ul style="list-style-type: none"> <li>• <b>Power:</b> 24V DC &gt;500mA plug pack</li> <li>• <b>Outputs:</b> 2 x dry connect relays for motor/bell press connection.</li> <li>• <b>Inputs:</b> 2 x Photo Eye Beams (PEB) Refer to the compatibility list.</li> </ul>
PMGS	Powermesh Garage Door Sensor	Bluetooth®	<ul style="list-style-type: none"> <li>• <b>Battery:</b> CR2450</li> <li>• <b>IP rating:</b> IP66.</li> </ul>

### Dimensions (mm)

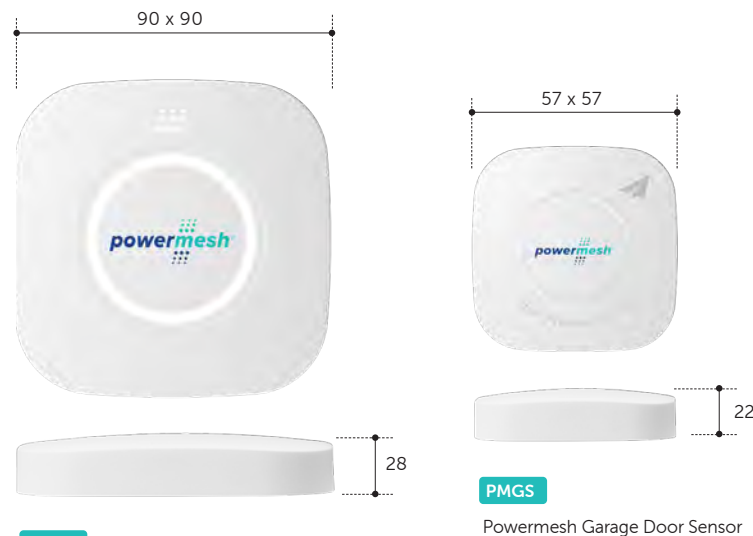

PMGC

Powermesh Garage Door Controller

PMGS

Powermesh Garage Door Sensor



**Garage door motor compatibility\*\***

Scan the code to download the User Manual.



14 Millennium Circuit, Helensvale, QLD 4212 Australia. [www.zimi.life](http://www.zimi.life)

Need help?

email [support@zimi.life](mailto:support@zimi.life)  
visit <https://support.zimi.life>



PMGCK

Powermesh Garage Door Controller and Sensor Kit.

#### Contains

- 1 x Garage Door Controller
- 1 x Garage Door Sensor
- 1 x 24V DC plug pack
- 1 x CR2450 battery

Bluetooth®

Download Zimi

Scan the code with your phone camera to download.



#### \* Zimi Cloud Connect

Enjoy the complete experience of all your Zimi devices with full functionality, reliable connectivity and energy history.





# Single Blind Controller



## Data Sheet

### Features

- Suits most AC blinds with separate active wires for open/close (refer compatibility list).
- Open and close button (press to stop).
- Double press button to open or close all blinds on the same network.
- LED indicator pulses while moving.
- Fits standard Australian wall boxes and mounting accessories that use 84mm mounting centres.
- Covers, plates and buttons are made from UV stabilised polycarbonate to avoid discolouring.
- 2 year warranty.
- Bluetooth mesh connectivity with each device acting as a repeater.
- Silverfish antenna technology.
- Automatic schedules.
- Power outage recovery.
- Night light on/off and auto dim.
- Voice control with your favourite voice assistant.\*

Learn more at [www.zimi.life](http://www.zimi.life)

### Specifications

Product Code	Colour	Description
PMBC2	White	Powermesh Blind Controller
PMBC2BK	Black	

- Small motor rating:** M.40
- Load rating:** 600W (2.5A) max
- Rating:** 230V~ 50Hz

### Dimensions (mm)

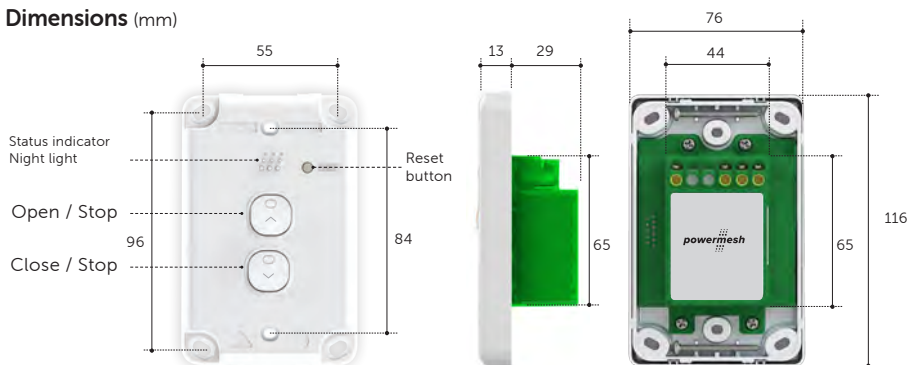

### Wiring Guide

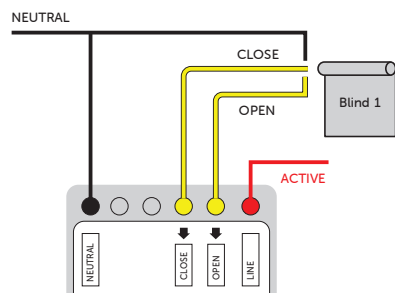

PMBC2



PMBC2BK

**Standards Approval:**  
AS/NZ60669.2.1 & AS/NZS CISPR15

**Certification Number:**  
GMA-506939-EA



**Download Zimi**  
Scan the code with your phone camera to download.



### \* Zimi Cloud Connect

Enjoy the complete experience of all your Zimi devices with full functionality, reliable connectivity and energy history.



14 Millennium Circuit, Helensvale, QLD 4212 Australia. [www.zimi.life](http://www.zimi.life)

Need help?

email [support@zimi.life](mailto:support@zimi.life)  
visit <https://support.zimi.life>

Powermesh products must be installed by a qualified electrician. Zimi requires a compatible (Android, iOS) mobile device, minimum OS requirements are available at [www.zimi.life](http://www.zimi.life). Availability and performance of certain features are service, device and network-dependent and may not be available in all areas; subscription(s) may be required, and additional terms, conditions and/or charges may apply. All features, functionality and other product specifications are subject to change without notice or obligation. Powermesh products are optimised for the use with the Zimi App. The Bluetooth word mark and logos are registered trademarks owned by the Bluetooth SIG, Inc. iOS is a trademark or registered trademark of Cisco Inc. Zimi and Powermesh and their respective logos are registered trademarks of Zimi Ltd. Google and Google Play are trademarks of Google LLC. Amazon, Alexa, and all related logos are trademarks of Amazon.com, Inc. or its affiliates. Apple, the Apple logo, Apple Watch and iPhone are trademarks of Apple Inc., registered in the U.S. and other countries. App Store is a service mark of Apple Inc., registered in the U.S. and other countries. Copyright © 2022 Zimi Ltd. All rights reserved.

# Dual Blind Controller



## Data Sheet

### Features

- Suits most AC blinds with separate active wires for open/close (refer compatibility list).
- Open and close button (press to stop).
- Double press button to open or close all blinds on the same network.
- LED indicator pulses while moving.
- Fits standard Australian wall boxes and mounting accessories that use 84mm mounting centres.
- Covers, plates and buttons are made from UV stabilised polycarbonate to avoid discolouring.
- 2 year warranty.
- Bluetooth mesh connectivity with each device acting as a repeater.
- Silverfish antenna technology.
- Automatic schedules.
- Power outage recovery.
- Night light on/off and auto dim.
- Voice control with your favourite voice assistant.\*

Learn more at [www.zimi.life](http://www.zimi.life)

### Specifications

Product Code	Colour	Description
PMBC4	White	Powermesh Dual Blind Controller
PMBC4BK	Black	

- Small motor rating:** M.40
- Load rating:** 600W (2.5A) max per channel
- Rating:** 230V~ 50Hz

### Dimensions (mm)

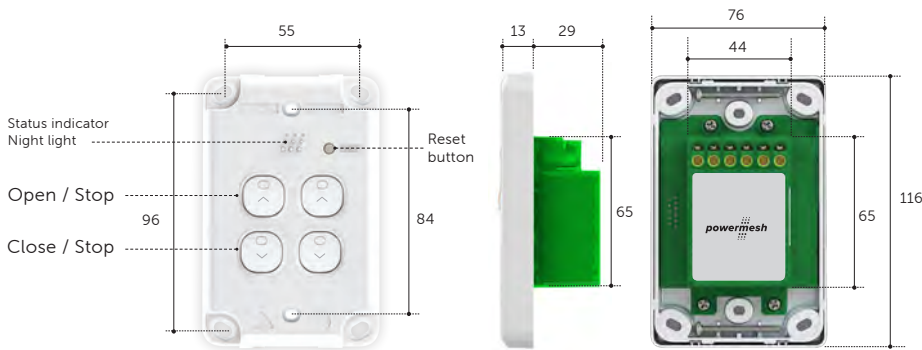

### Wiring Guide

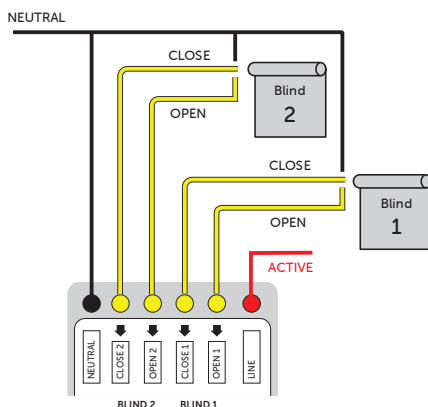

PMBC4



PMBC4BK

**Standards Approval:**  
AS/NZ60669.2.1 & AS/NZS CISPR15

**Certification Number:**  
GMA-506939-EA



**Download Zimi**  
Scan the code with your phone camera to download.



### \* Zimi Cloud Connect

Enjoy the complete experience of all your Zimi devices with full functionality, reliable connectivity and energy history.



14 Millennium Circuit, Helensvale, QLD 4212 Australia. [www.zimi.life](http://www.zimi.life)

Need help?

email [support@zimi.life](mailto:support@zimi.life)  
visit <https://support.zimi.life>

Powermesh products must be installed by a qualified electrician. Zimi requires a compatible (Android, iOS) mobile device, minimum OS requirements are available at [www.zimi.life](http://www.zimi.life). Availability and performance of certain features are service, device and network-dependent and may not be available in all areas; subscription(s) may be required, and additional terms, conditions and/or charges may apply. All features, functionality and other product specifications are subject to change without notice or obligation. Powermesh products are optimised for the use with the Zimi App. The Bluetooth word mark and logos are registered trademarks owned by the Bluetooth SIG, Inc. iOS is a trademark or registered trademark of Cisco Inc. Zimi and Powermesh and their respective logos are registered trademarks of Zimi Ltd. Google and Google Play are trademarks of Google LLC. Amazon, Alexa, and all related logos are trademarks of Amazon.com, Inc. or its affiliates. Apple, the Apple logo, Apple Watch and iPhone are trademarks of Apple Inc., registered in the U.S. and other countries. App Store is a service mark of Apple Inc., registered in the U.S. and other countries. Copyright © 2022 Zimi Ltd. All rights reserved.

# Multi Dimmer Switch

## 2 Button



### Data Sheet

#### Features

- Fits standard Australian wall boxes and mounting accessories that use 84mm mounting centres.
- Trailing edge dimmer.
- Bluetooth mesh connectivity with each device acting as a repeater.
- Silverfish antenna technology.
- Over current, temperature, and voltage protection.
- Ripple Smooth™ dimming technology.
- 2 year warranty.
- Covers, plates and buttons are made from UV stabilised polycarbonate to avoid discolouring.
- Dimming Control. Press - on/off. Hold - dimming. Double press - full brightness. Triple press - timed fade to off.
- Auto off timers.
- Real time energy use in watts & dollars.
- Automatic schedules.
- Power outage recovery.
- Night light on/off and auto dim.
- Multi way switching of other Zimi devices using Behaviour Link.
- Min and max dimming levels for increased compatibility without flicker.
- Voice control with your favourite voice assistant.\*

Learn more at [www.zimi.life](http://www.zimi.life)

#### Specifications

Product Code	Colour	Description	Rating
PMMDS2	White	Powermesh Multi Dimmer Switch 2 Button	230V~ 50Hz
PMMDS2BK	Black		

Load Type	Symbol	Rated Load	
		Dimmer	Switch
LED drivers & lamps		250W	230W
Incandescent		100W	5A
Fluorescent		×	2AX
Electronic transformers		×	2A
Standard iron core & toroidal transformers		×	2A
Small motors		×	M.20

#### Wiring Guide

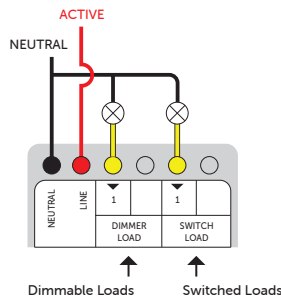

PMMDS2



PMMDS2BK

Standards Approval:  
AS/NZ60669.2.1 & AS/NZS CISPR15

Certification Number:  
GMA-514117-EA



#### Dimensions (mm)

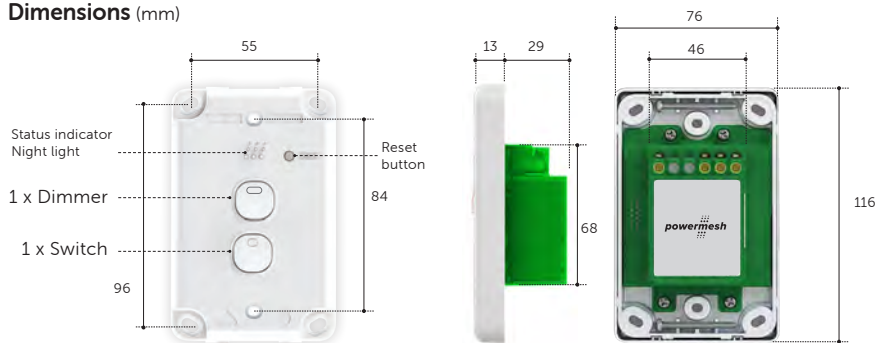

Download Zimi  
Scan the code with your phone camera to download.



#### \* Zimi Cloud Connect

Enjoy the complete experience of all your Zimi devices with full functionality, reliable connectivity and energy history.



**zimi** 14 Millennium Circuit, Helensvale, QLD 4212 Australia. [www.zimi.life](http://www.zimi.life)

Need help? email [support@zimi.life](mailto:support@zimi.life)  
visit <https://support.zimi.life>



Powermesh products must be installed by a qualified electrician. Zimi requires a compatible (Android, iOS) mobile device, minimum OS requirements are available at [www.zimi.life](http://www.zimi.life). Availability and performance of certain features are service, device and network-dependent and may not be available in all areas; subscription(s) may be required, and additional terms, conditions and/or charges may apply. All features, functionality and other product specifications are subject to change without notice or obligation. Powermesh products are optimised for the use with the Zimi App. The Bluetooth word mark and logos are registered trademarks owned by the Bluetooth SIG, Inc. iOS is a trademark or registered trademark of Cisco Inc. Zimi and Powermesh and their respective logos are registered trademarks of Zimi Ltd. Google and Google Play are trademarks of Google LLC. Amazon, Alexa, and all related logos are trademarks of Amazon.com, Inc. or its affiliates. Apple, the Apple logo, Apple Watch and iPhone are trademarks of Apple Inc., registered in the U.S. and other countries. App Store is a service mark of Apple Inc., registered in the U.S. and other countries. Copyright © 2022 Zimi Ltd. All rights reserved.

# Multi Dimmer Switch

## 4 Button



### Data Sheet

#### Features

- Fits standard Australian wall boxes and mounting accessories that use 84mm mounting centres.
- Trailing edge dimmer.
- Bluetooth mesh connectivity with each device acting as a repeater.
- Silverfish antenna technology.
- Over current, temperature, and voltage protection.
- Ripple Smooth™ dimming technology.
- 2 year warranty.
- Covers, plates and buttons are made from UV stabilised polycarbonate to avoid discolouring.
- Dimming Control. Press - on/off. Hold - dimming. Double press - full brightness. Triple press - timed fade to off.
- Auto off timers.
- Real time energy use in watts & dollars.
- Automatic schedules.
- Power outage recovery.
- Night light on/off and auto dim.
- Multi way switching of other Zimi devices using Behaviour Link.
- Min and max dimming levels for increased compatibility without flicker.
- Voice control with your favourite voice assistant.\*

Learn more at [www.zimi.life](http://www.zimi.life)

#### Specifications

Product Code	Colour	Description	Rating
PMMDS4	White	Powermesh Multi Dimmer Switch 4 Button	230V~ 50Hz Max 10A total
PMMDS4BK	Black		

Load Type	Symbol	Rated Load	
		Dimmer	Switch
LED drivers & lamps		250W	230W
Incandescent		100W	5A
Fluorescent		×	2AX
Electronic transformers		×	2A
Standard iron core & toroidal transformers		×	2A
Small motors		×	M.20

#### Wiring Guide

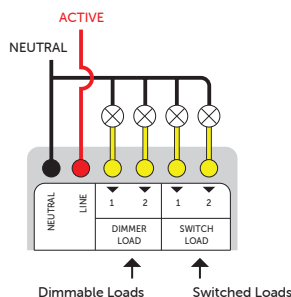

**PMMDS4**



**PMMDS4BK**

**Standards Approval:**  
AS/NZ60669.2.1 & AS/NZS CISPR15

**Certification Number:**  
GMA-511367-EA



#### Dimensions (mm)

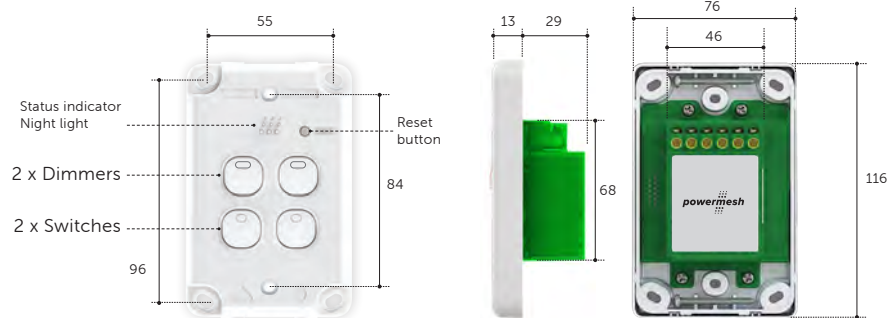

**Download Zimi**  
Scan the code with your phone camera to download.



#### \* Zimi Cloud Connect

Enjoy the complete experience of all your Zimi devices with full functionality, reliable connectivity and energy history.



14 Millennium Circuit, Helensvale, QLD 4212 Australia. [www.zimi.life](http://www.zimi.life)

Need help?

email [support@zimi.life](mailto:support@zimi.life)  
visit <https://support.zimi.life>









Powermesh products must be installed by a qualified electrician. Zimi requires a compatible (Android, iOS) mobile device, minimum OS requirements are available at [www.zimi.life](http://www.zimi.life). Availability and performance of certain features are service, device and network-dependent and may not be available in all areas; subscription(s) may be required, and additional terms, conditions and/or charges may apply. All features, functionality and other product specifications are subject to change without notice or obligation. Powermesh products are optimised for the use with the Zimi App. The Bluetooth word mark and logos are registered trademarks owned by the Bluetooth SIG, Inc. iOS is a trademark or registered trademark of Cisco Inc. Zimi and Powermesh and their respective logos are registered trademarks of Zimi Ltd. Google and Google Play are trademarks of Google LLC. Amazon, Alexa, and all related logos are trademarks of Amazon.com, Inc. or its affiliates. Apple, the Apple logo, Apple Watch and iPhone are trademarks of Apple Inc., registered in the U.S. and other countries. App Store is a service mark of Apple Inc., registered in the U.S. and other countries. Copyright © 2022 Zimi Ltd. All rights reserved.

PMBUSW



Compatible load types

-  LED
-  Incandescent
-  Fluorescent
-  CFLs
-  Electronic transformers
-  Standard iron core & toroidal transformers
-  Exhaust fans / small motors

Cleaning Guide:

Spraying cleaning products directly on to electrical switches or power points (sockets) is not recommended. It is important to ensure that switches are turned off before cleaning.

Do not use any cleaning sprays - only wipe down with damp cloth or rub with dry cloth. (Do not use an abrasive cloth as it may scratch the plastic). Do not use harsh chemical cleaners as these can break down the plastic and cause it to crack. Do not wash the cover plates in water over 60°C.

Trader Powermesh products must be installed by a qualified electrician. Zimi requires a compatible (Android, iOS) mobile device. All features, functionality and other product specifications are subject to change without notice or obligation. Powermesh products are optimised for the use with the Zimi App. The Bluetooth word mark and logos are registered trademarks owned by the Bluetooth SIG, Inc. The Trader logo is a registered trademark of GSM Electrical (Australia) Pty. Ltd. IOS is a trademark or registered trademark of Cisco Inc. Zimi and Powermesh and their respective logos are registered trademarks of GSM Innovations Pty Ltd. Google Play and the Google Play logo are trademarks of Google Inc. App Store is a service mark of Apple Inc., registered in the U.S. and other countries.

© Copyright 2018 GSM Electrical (Australia) Pty. Ltd. All rights reserved

# Powermesh Weatherproof Switch

## Multi Purpose Switch Weather Protected to suit Trader Buffalo range

- Approved to AS/NZ60669.2.1 & AS/NZS CISPR15.
- Switch terminals have 4mm bore to suit 1.5mm<sup>2</sup> cable.
- Soft touch control.
- Indicator displays the on/off state.
- Software control using the Zimi app, available on the Google Play and App Store.
- Covers, plates and dollies are made from UV stabilised polycarbonate to avoid discolouring to yellow.
- Rating 240V AC 50Hz, 10AX.
- Neutral connection required (3 wire).
- Multi way switching with multiple devices using 'Behaviour link' (configured using the Zimi app).
- M60 motor rating.
- Inbuilt scheduling.
- Power outage recovery.
- Control anywhere in the world via the Internet with the Zimi Cloud Connect. (Product Code: PMZCLOUDV1)
- IP66.
- Suits mounting on Buffalo boxes/enclosures.
- Can multi-gang with other Buffalo products.

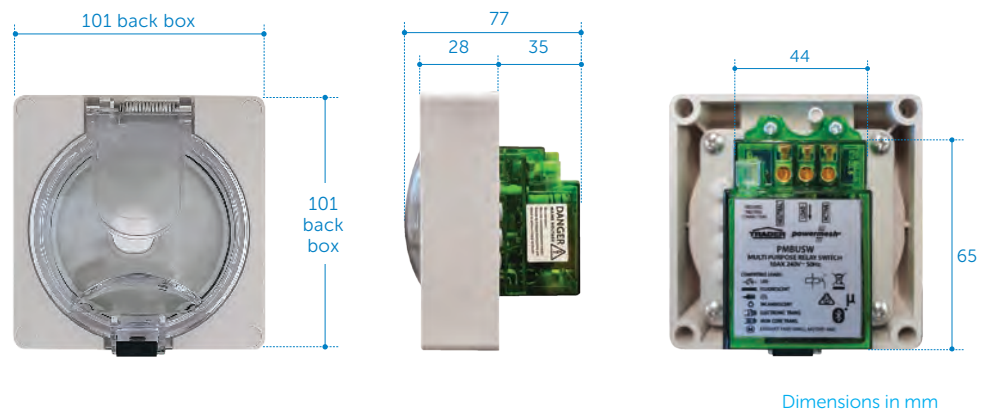

Catalogue Number	Description
PMBUSW	Powermesh Multi Purpose Switch 1 Button 10AX 240V 3 Wire Only Buffalo Enclosure IP66



**GSM Electrical (Australia) Pty Ltd**  
Level 2, 142-144 Fullarton Road, Rose Park SA 5067  
P: 1300 301 838 F: 1300 301 778 E: service@gsm.com.au  
[www.gsm.com.au](http://www.gsm.com.au)